

BID SUBMITTAL FORM
Alabama County Joint Bid Program
BID ITEM – 16' DUMP BODY - OPTION E AUTOMATIC

Company Name: Childersburg Truck Service, Inc.

Address: 33790 U.S. Hwy. 280
Childersburg, AL 35044

Bid Submitted by: Roger Justice
(Name of company representative)

Title: General Manager E-mail address: roger-justice@childersburg-trucks.com

Phone: 256-378-3101 Fax:

By submitting this bid, we agree:

Initials

That the equipment model number identified below meets the bid specs for this bid item RJ

That the bid price will be honored for all counties for the period from January 1, 2023 to December 31, 2023. R.J.

That the equipment will be delivered at the bid price to all counties participating in the joint bid program R.J.

That the company representative listed above will be the contact person for purchasing this bid item under the joint bid program R.J.

That the bid is accompanied by a current catalog or model specification document for the model number identified below R.J.

That the bid is accompanied by a copy of the manufacturer's standard warranty as required in the bid specifications R.J.

That the bid includes the e-verify documentation required by Alabama law R.J.

That, if awarded the bid, a performance bond will be provided upon request R.J.

That an option sheet with individual pricing is attached R.J.

Total Bid Price including options: \$ 46,251.⁰⁰

Equipment Model #: 16' Maverick

Description: 16'x60" Maverick

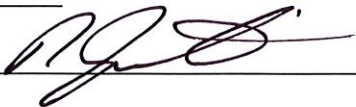
Signature of company representative submitting bid: 

Title: General Manager

OPTION COST SHEET FOR 16' STEEL DUMP BODY – OPTION E (AUTOMATIC TRANSMISSION)

Tri Axle Option Items	<u>Option Price</u>
Silent Drive or Equal Lift Axle	\$ <u>5500.⁰⁰</u>
Four Steel Disc, Ten hole, hub piloted, bud style 22.5x8.25 wheels on lift axle	\$ <u>520.⁰⁰</u>
Four 11R22.5 recap tires on lift axle	\$ <u>984.⁰⁰</u>

<u>Other Options</u>	<u>Option Price</u>
High lift tail gate	\$ <u>1163.⁰⁰</u>
Bed body vibrator	\$ <u>819.⁰⁰</u>
25-ton heavy duty Pintle Hitch	\$ <u>1450.⁰⁰</u>
Chip Spreader bar mounted	\$ <u>435.⁰⁰</u>

NOTE: Award will be made on the basis of the total cost of the machine with all options included. However, a county may, at its discretion, deduct one or more of the above-referenced options from the machine, and in such event, the cost of the option as stated on the bid shall be deducted from the total cost of the machine. There shall be no other deductions and no additions made to the machine by the purchasing county or by the vendor.

Equipment Model #: 16' Maverick

Description: 16'x60" Maverick

Signature of company representative submitting bid: 

Title: General Manager

BID SPECIFICATIONS

16' STEEL DUMP BODY - OPTION E

(AUTOMATIC TRANSMISSION)

GENERAL

These specifications shall be construed as the minimum acceptable standards for a 16' Steel Dump Body. Should the manufacturer's current published data or specifications exceed these standards, the manufacturer's standards shall be considered minimum and shall be furnished. All integral parts not specifically mentioned in the scope of these specifications that are necessary to provide a complete working unit shall be furnished. Additionally, the machine offered for bid shall include all standard manufacturer's equipment. The 16' Steel Dump Body must be a new current production model.

The use of specific names or numbers in the specifications is not intended to restrict the bidder or any seller or manufacturer, but is intended solely for the purpose of indicating the type, size, and quality of equipment considered best adapted to the uses of counties participating in this joint bid.

BID SUBMITTAL FORM

Each bidder must submit his or her bid on the Bid Submittal Form included in the invitation to bid package. All written warranties to be submitted shall be attached to the Bid Submittal Form.

BID PRICE

The price bid shall include all destination charges, delivery charges, title fees, rebates and all other applicable costs and refunds.

REPLACEMENT PARTS AVAILABILITY

Parts must be available for 5 years or 500,000 miles of use for the piece of equipment bid.

ASSEMBLY AND DELIVERY

The dump body will be purchased for use with a heavy-duty dump truck chassis (with Automatic Transmission) bid separately. The dump body company will be responsible for assembly and installation of the dump body and related optional equipment, including the cost of the same. The selling truck chassis dealer will be responsible for delivery of the chassis to the dump body company, for installation and for delivery of the complete dump truck unit to the county following installation, and assembly of the dump body and related options onto the truck chassis. Freight to and from the dump body company will be included in the truck bidder's proposal. Dump body installation and assembly costs will be included in the dump body bidder's proposal.

WARRANTY

Bidders shall submit a copy of the manufacturer's standard warranty.

Yes No
Page# 1-4
Or
Attachment

DUMP BODY

Dump body shall meet all federal and state, health and safety regulations and must conform to American National Standard Institute (A.N.S.I.) Regulations (A.N.S.I.Z145) 1975.

Yes No
Page # _____

Dump body supplier must have their own service and parts facility.

Yes No
Page # _____

Dump body supplier must have a minimum of five (5) years' experience in sales, service and repair of dump bodies.

Yes No
Page # _____

Body must be covered by product liability insurance.

Yes No
Page # _____

GENERAL OPERATING SPECIFICATIONS AND DIMENSIONS

21 cubic yard capacity; 16 feet long; 60-inch high sides; 60- inch high tailgate; sides, tailgate, floor shall be ¼ inch AR 450 steel; tailgate shall be sloping with a six (6) inch slope; 8" x 2" Rectangular Tubing Long Sills (Main Runners); 1.5" x 3" rectangular tubing cross-members on 12" centers; HYVA 74133 hoist that shall be class 120 hoist with a minimum four (4) active stages and minimum 60,000 pound capacity; direct mount integral pump and P.T.O. combination with air control on the P.T.O.; air tailgate latch control; electric tarp with vinyl asphalt type tarp; 42 inch cab shield, eight (8) inch wide schedule 80-pipe push bar asphalt apron across rear of body; 3.5 inch inverted angle on top of sides and top of tailgate; rib reinforced sidewalls and three (3) pane tailgate design; and Metro light kit.

Yes No
Page # 5

TRI AXLE OR HEAVY-DUTY DUMP TRUCK CHASSIS OPTIONS

The chassis (with Automatic Transmission) will be used as a tri axle dump or a heavy-duty tandem dump. All bids shall include the cost for each of the following options to be selected for a tri axle dump, itemized separately on the bid:

Silent Drive Lift (Pusher) axle (20,000 lb minimum Capacity) or Equal. This axle shall be air up and air down with a control valve and regulator located in the cab within reach of the operator.

Yes No
Page # 6-7

Four (4) steel disc, ten (10) hole, hub piloted, bud style 22.5x8.25, wheels on lift axle.

Yes No
Page # _____

Four 11R22.5 recap tires on lift axle.

Yes No
Page # _____

OTHER OPTIONS

Bid must include the cost for each of the following options, itemized separately on the bid:

High lift tail gate

Yes No
Page # on Brochure

Bed body vibrator

Yes No
Page # _____

25-ton heavy duty Pintle Hitch, swivel type, spring loaded, with safety chain rings, six (6) prong trailer light socket and air brakes hookup. Mounted 26 inches from ground with truck empty.

Yes No
Page # 8

Chip spreader bar mounted at end of frame.

Yes No
Page # _____

NOTE: Award will be made on the basis of the total cost of the dump body with all options included. However, a county may, at its discretion, deduct one or more of the above-referenced options from the dump body, and in such event, the cost of the options as stated on the bid shall be deducted from the total cost of the dump body. There shall be no other deductions and no additions made to the dump body by the purchasing county or by the vendor.

INVITATION TO BID HEAVY EQUIPMENT

NOTICE OF BID OPENING

NOTICE IS HEREBY GIVEN that the Association of County Commissions of Alabama, which administers the Alabama County Joint Bid Program on behalf of Alabama's county governing bodies, shall receive and open bids for the purchase of zero (0) or more items of heavy road equipment at its office located at 2 North Jackson Street, Montgomery, Alabama, at **10:00 a.m. on Friday, October 7, 2022**. Bid specifications are available at <http://www.alabamacounties.org/heavy-equipment/> for each of the following items:

Backhoes
Tractors
Track Mount Excavators
Compact Track Mount Excavators
Mini Track Excavator
Wheeled Excavators
Highway Speed Truck Excavators
Motor Graders
Heavy Duty Hydrostatic Bulldozers
Mulching Dozer
Wheel Loaders
Heavy Duty Dump Chassis
Lowboy Tractors
Skid Steer Loader w/no Attachments

Skid Steer Attachments
Ride-on Industrial Boom Mowers
Asphalt Distributor Truck
Chip Spreader
Rubber Tire Roller
7.5 Ton Single Drum Vibratory Roller
One-man Pothole Patchers
Trailer Mounted Patchers
Trailer Mount Mastic Patcher/Crack Sealer
Half Round End Dump Trailer
Lowboy Trailers
Road Wideners and Attachments
16' Steel Dump Bodies (Automatic and Manual)

Time is of the essence in submitting bids and only bids received in the Association office by 10:00 a.m. Central Time on Friday, October 7, 2022 will be opened and considered. Bidders and any other interested individuals are invited to attend the bid opening.

NOTICE OF BID OPENING PROCEDURES

All bids for **Heavy Equipment** will be opened and the name(s) of the bidders read aloud on the morning of the bid opening on Friday, **October 7, 2022 at 10:00 a.m.** at 2 North Jackson Street, Montgomery, AL. The specifics of each bid submitted will be compiled by the Association staff thereafter and will be available, **upon written or emailed request**, one week after the bid opening. Requests should be emailed to jointbid@alabamacounties.org.

THE INVITATION PACKAGE

The invitation package for each item to be bid includes: this invitation to bid, the written bid specifications for the particular item of heavy road equipment, and a Bid Submittal Form to be used in submitting a bid for that particular item. Bidders should verify that they have received all pages of the invitation package. If there are any omissions, the bidder should contact Kenya Howard in the Association office by mail, fax, or e-mail (jointbid@alabamacounties.org) to request missing pages. It is the responsibility of the bidder to make this request in sufficient time to prepare and submit the bid in time for the bid opening. Bidders should carefully read and comply with all parts of the invitation package, including all attachments and/or any addendum.

PREPARING AND SUBMITTING BIDS

All bids must be typed or hand written in ink on the attached Bid Submittal Form. **The completed Bid Submittal Form shall be placed in front of and separated from all other documents included in the bid packet, such that it will be the first document viewed upon opening the bid packet.**

Bids submitted in pencil and bids not submitted on the Bid Submittal Form will **not** be considered. All bids shall include a current catalog or model specification document for the equipment model number being offered for consideration. Bids submitted without such documentation will **not** be considered. Only information contained on the attached Bid Submittal Form and in the model specification document will be considered in evaluating bids.

Each separate requirement in the bid specification includes a block for indicating whether or not the item bid meets the specification. The bidder shall indicate compliance with each requirement by checking "Yes" or "No" in the block to the right of each bid specification. In addition, the bidder shall indicate the page number in the supplied manufacturer's equipment literature on which compliance with the specification can be verified. Failure to complete this portion of the bid form may result in the subject bid not being considered. Additionally, all bidders are required to submit a factory build/order sheet showing all of the standard and option items for each piece of equipment bid in order to assist the bid review committee in assuring that each bid is in conformance with the required bid specifications.

Each bid for one of the heavy equipment items included in the bid package must be submitted on the Bid Submittal Form for that item and forwarded in a separate envelope with the bid item and item number clearly identified on the outside of the envelope. Envelopes containing a "no bid" shall also include the words "NO BID" on the outside of the envelope. Facsimiles and e-mails will not be accepted. Bids submitted by "Express/Overnight" services must be in a separate inner envelope or package sealed and identified as stated above. All bids must be received in the Association office prior to the bid opening. Bids received after the deadline will be returned unopened.

The County Joint Bid Program reserves the right to require a performance bond from successful bidders as permitted under Alabama law. However, **no bid bond is required for this bid offering.**

All bids should be mailed or hand-delivered to:

**ATTN: Joint Bid Program
Association of County Commissions of Alabama
2 North Jackson Street, FL 7, Montgomery, Alabama 36104 (Physical Address)
P.O. Box 5040, Montgomery, Alabama 36103 (Mailing Address)**

BID SPECIFICATIONS

Please note that each piece of heavy equipment available for bid may include several different sizes and categories of machines. You should read each set of specifications very carefully as the differences vary depending upon the piece and size of equipment.

Where applicable, each bid submission shall include the separate cost of each item listed in the "Options" section of the bid specifications. However, all bids will be awarded on the basis of the **total cost of the machine with all options included**. Therefore, the "Bid Price" stated on the Bid Submittal Form must be the total cost, including the cost of all options.

Once the bids have been awarded, any county participant purchasing under this program may, at its discretion, deduct one or more of the options set out in the bid specifications, and in such event, the cost of the option as stated on the bid shall be deducted from the total cost of the machine. There shall be no other deductions and no additions made to the machine by the purchasing county or by the vendor.

Any use of specific names and/or model numbers in the attached specifications is not intended to restrict the bidder or any seller or manufacturer, but is included solely for the purpose of indicating the type, size, and quality of materials, product services, or equipment considered best adapted to the use of the counties participating in the joint bid program.

BIDDER QUALIFICATIONS

All bidders and all program participants must be in compliance with any applicable federal, state, county and municipal laws, regulations, resolutions and ordinances, including but not limited to, licensing, permitting, and taxation requirements. All bidders should be prepared to submit evidence or documentation as proof that they are properly licensed and permitted under any applicable laws upon request. Such evidence or documentation may be submitted with the bid. Additionally, all bidders shall provide proof that they are in compliance with the e-verify requirements of Alabama's Immigration Law (Ala. Code § 31-13-1 et seq., as amended by Act No. 2012-491).

BID AWARD

The Houston County Commission will serve as the awarding authority for all bids and will award all contracts at a regular meeting of the Houston County Commission. Any and all bids submitted in compliance with this invitation to bid shall be considered, and award will be made to the lowest responsible bidder meeting bid specifications as determined by the awarding authority in compliance with Alabama law. All bids will be reviewed and evaluated by a committee created for that purpose, which committee will make comments and recommendations to the awarding authority regarding the award. All factors contained in each invitation package will be evaluated in determining the successful bidder, and any omissions of the stated requirements may be cause for rejection of the bid submitted. The awarding authority reserves the right to reject any and all bids, to waive any informality in bids, and to accept in whole or in part such bid or bids solely at its discretion.

The contract period will be one year with an option to renew for a second and third year under identical price, terms, and conditions upon the mutual consent of the vendor and the awarding authority. Any renewal contract shall be approved in writing by the vendor and the awarding authority no later than 90 days prior to the expiration of the existing contract.

CONTACT REGARDING BIDS AND INVITATION

Contact initiated by a potential bidder with any county official, county employee, or member of the Association staff shall only be as specifically set out in this Invitation to Bid. Any questions related to the bid or the County Joint Bid Program shall be directed to Association staff in writing under the procedures set out in this Invitation to Bid. Additionally, a bidder may contact the Association in writing to request an appointment to review bid specifications following the bid opening. **However, there shall be no communication with any county official or county employee regarding this bid between the date of this invitation and the date of bid award.** Any contact other than as set out here shall be deemed as an attempt to unduly influence the bid award, and shall be grounds for rejection of the bid submitted by the bidder initiating such other contact.

Any questions or problems related to downloading or obtaining copies of this Invitation to Bid should be directed to **Kenya Howard** at jointbid@alabamacounties.org or **334-263-7594**.

Any other questions or requests for additional information regarding this invitation or the bid specifications shall be submitted **in writing** no later than five (5) days prior to bid opening to:

ATTN: Patrick McDougald
Association of County Commissions of Alabama
P.O. Box 5040
Montgomery, Alabama 36104

OR

Patrick McDougald
E-mail: barbeng@bellsouth.net

Company ID Number: 488359

To be accepted as a participant in E-Verify, you should only sign the Employer's Section of the signature page. If you have any questions, contact E-Verify at 888-464-4218.

Employer Childersburg Truck Service, Inc.	
Jason Hernandez	
Name (Please Type or Print)	Title
Electronically Signed	01/11/2012
Signature	Date
Department of Homeland Security – Verification Division	
USCIS Verification Division	
Name (Please Type or Print)	Title
Electronically Signed	01/11/2012
Signature	Date

Information Required for the E-Verify Program

Information relating to your Company:

Company Name:	Childersburg Truck Service, Inc.
Company Facility Address:	33790 US Hwy 280, East Childersburg, AL 35044
Company Alternate Address:	P.O. Drawer T Childersburg, AL 35044
County or Parish:	TALLADEGA
Employer Identification Number:	630756580

Company ID Number: 488359

North American Industry Classification Systems Code:	423
Administrator:	
Number of Employees:	10 to 19
Number of Sites Verified for:	1
<p>Are you verifying for more than 1 site? If yes, please provide the number of sites verified for in each State:</p> <ul style="list-style-type: none"> ALABAMA 1 site(s) 	

Information relating to the Program Administrator(s) for your Company on policy questions or operational problems:

Name:	Jason Hernandez	Fax Number:	(256) 378 - 5660
Telephone Number:	(256) 378 - 3101		
E-mail Address:	todd_hernandez@childersburg-truck.com		
Name:	Vanda G Wallace	Fax Number:	(256) 378 - 5660
Telephone Number:	(256) 378 - 3101		
E-mail Address:	vanda@childersburg-truck.com		
Name:	Roger H Justice	Fax Number:	(256) 378 - 0346
Telephone Number:	(256) 378 - 3101		
E-mail Address:	roger_justice@childersburg-truck.com		
Name:	Vicky G Rhodes	Fax Number:	(256) 378 - 5660
Telephone Number:	(256) 378 - 3101		
E-mail Address:	vicky@childersburg-truck.com		

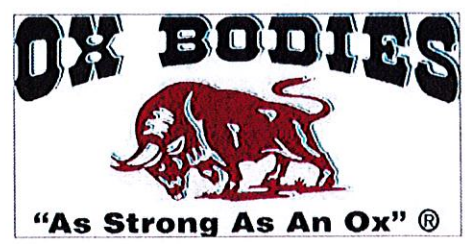

Ox Bodies Warranty Procedure

Please note: No warranty repair or invoice will be considered unless authorization has been obtained from and warranty repair authorization (WRA) number has been issued by the Ox Bodies warranty administrator.

**www.oxbodies.com oxwarranty@tbei.com
1-800-844-2519 Fax: 205-392-5794**

Ox Bodies warrants only products manufactured and/or installed at one of its three locations:

Ox Bodies, Inc Alabama 719 Columbus St. East Fayette, Alabama 35555	Ox Bodies, Inc South Carolina 195 Industrial Lane Bennettsville, SC 29512
---	---

Ox Bodies, Inc Arkansas
139 Old Airport Rd.
Nashville, AR 71852

or at its authorized installer:

TBEI Lakeland Operations
4220 Drane Field Rd.
Lakeland, FL 33811

In cases where product failure occurs due to defects in materials and/or workmanship; within the limitations set forth by the Ox Bodies limited warranty and during the warranty time period, a claim must be filed within thirty (30) days of such failure.

If the truck body or accessory was purchased through a dealer, please contact the dealer and they will coordinate with Ox Bodies if the defect is warrantable. Other users may contact the Warranty Administrator directly using the information above. Ox Bodies will make the following allowances to authorized distributors:

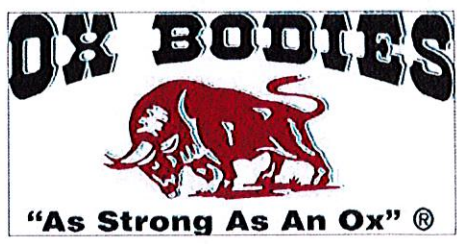

1. In an effort to reduce distributor's freight costs, Ox Bodies may choose to have the defective part scrapped at the Distributor location. In such cases, the distributor may be required by the Warranty Administrator to provide photographs of the part(s) in question along with the submission of the warranty claim. In cases where the part has an identification/serial number tag of its own (in addition to the Ox Bodies serial number on the truck body itself), that information must also be included with the warranty claim. The part(s) must be retained by the distributor until such time as the warranty claim has been finalized.

2. Ox Bodies will provide a Warranty Repair Authorization (WRA) number when the Warranty Administrator determines an issue meets the conditions of a warrantable failure. Any returned material must be clearly labeled with this number on the shipping label and packing slip. Parts received without this identification number will not be credited.

3. Parts to be warranted must be received within fourteen (14) days of shipment of replacement part. Parts not received within this time period will not be credited, and the distributor will be charged for the replacement component unless prior arrangements have been made with the Warranty Administrator for consideration of extenuating circumstances.

4. Components of Ox Bodies manufacture which are returned and determined upon our inspection to be defective in materials and/or workmanship will be credited and/or repaired/replaced at no charge. Freight charges are to be submitted on the claim form. Please note; additional charges will not be paid for expedited shipments of replacement parts.

5. All Freight collect shipments of returned materials will be refused.

6. Vendor made components must be returned for warranty consideration either to the component manufacturer, or to Ox Bodies Warranty department in Fayette, Alabama. Ox Bodies Warranty Administrator will determine the ship-to location. Prior to returning these components, shipping arrangements must be made by contacting the Warranty Administrator for a WRA number.

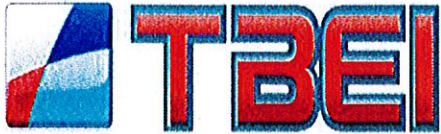

TRUCK BODIES & EQUIPMENT INTERNATIONAL, Inc.

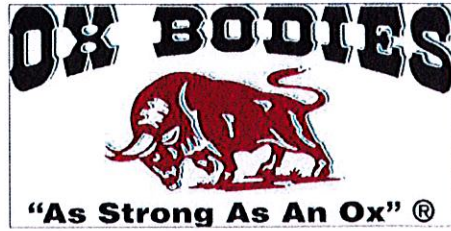

7. Repairs are to be performed solely with parts manufactured, rebuilt, or supplied by Ox Bodies, exclusively by authorized repair shops. Warranty will not be allowed when other manufacturer's replacement parts are used, or when performed by other than an Ox Bodies approved repair shop unless authorized by Ox Bodies Warranty prior to beginning repairs. *(see # 8 for details on conditions for prior approval)* Ox Bodies repair and/or replacement parts will be covered by Ox Bodies standard written warranty for a period of one (1) year.

8. Distributors may arrange with Ox Bodies warranty to perform the repair(s) themselves. In these cases, Ox Bodies will credit the distributor for the cost of labor incurred in replacing defective components based on the hours listed in the Warranty Flat Rate Schedule in this document. No additional time will be allowed unless a full explanation is furnished as to possible extenuating circumstances and prior approval has been obtained. Standard hours are based on performance of properly equipped and adequately trained mechanics. No credit will be allowed for labor hours spent in inspection of equipment or diagnosis of equipment problems, as this is a function generally performed by supervisory personnel rather than direct labor.

9. In cases where there is no authorized repair shop or distributor at hand to perform repairs, Ox Bodies Warranty will arrange either to transport the unit to the nearest authorized repair shop/distributor or Ox Bodies facility; whichever is most convenient. Owners may choose to have repairs performed elsewhere, however reimbursement of labor charges will be according to the Flat Rate Schedule, and the repair may not be covered by the warranty.

10. Warranty consideration for repairs submitted by the distributor will be allowed according to the flat rate schedule only. Any difference in charges invoiced will be the responsibility of the distributor.

11. No credit for labor hours/parts will be issued for replacement of components that our inspection subsequently shows not to be defective.

12. No allowance will be made for travel time spent by the distributor to perform repairs.



TRUCK BODIES & EQUIPMENT INTERNATIONAL, Inc.

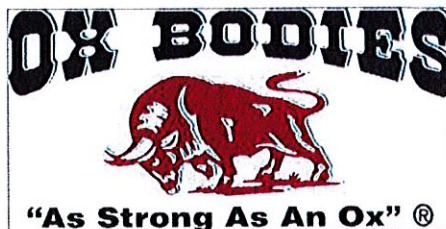

13. No allowance will be made for towing charges.

14. Claims will be allowed for replacement of hydraulic fluid only in cases where failure of a component clearly indicated loss of a major portion of the fluid in the system. The allowance shall not exceed the current average price per gallon.

15. Ox Bodies will investigate all claims submitted within the warranty period for the unit in question. If the claim is authorized, a WRA number will be issued. If the claim is rejected, a letter indicating the reason will be returned to the distributor.

OX BODIES



"As Strong As An Ox" ®

Childersburg Truck Service, Inc.

Post Office Drawer "T"
 33790 US HWY 280
 Childersburg, Alabama 35044
 Phone: (256) 378-3101 Fax: (256) 378-0346
 Sales: Bob Goins Service: Roger Justice
 Website: www.childersburg-truck.com

Quote Number	Customer	First Name	Last Name
CTS-20917	ACCA		

Address	City	State	Zip Code	Quantity
100 NORTH JACKSON STREET	MONTGOMERY	AL	36104	0

Phone	Fax	Date Quoted	Date Ordered	Date Delivered	VIN

Serial Number	Truck Model	Body Type	Frame Type	Yardage
		16 MAVERICK	Frameless	

Sides (Gauge)	Sides (Height)	Sides (Type)	Floor	Cross Member Spacing	Tailgate Type
1/4 AR-450	60 in.	Ribbed	1/4 AR-450	12 in.	Slanted

Tailgate Height	Tailgate Control	Cylinder	Cab Control	Cab Shield Length
62 in.	Air		Air P.T.O. - Felsted Pump	42 in.

Dump Apron	Apron Length	BackAlert	Paint	TarpType
Schedule 80 Pipe Push Bar	8 in.	Yes	Stock	Electric

Cover	Transmission	OB Number	Order Number
Vinyl			

Options

3X3X1/4" ANGLE ON TOP OF SIDES & GATE, HYVA 74133 HOIST, 3 PANEL TAILGATE.
 OPTIONS: AXLE, RIMS, RECAP TIRES, HIGH LIFT TAILGATE, BODY VIBRATOR, PINTLE HITCH,
 CHIP SPREADER BAR

Remarks: _____

Price:	\$0.00
Axle:	\$0.00
Other:	\$0.00
Freight:	\$0.00
FET:	\$0.00
Sales Tax:	\$0.00
Total:	\$0.00

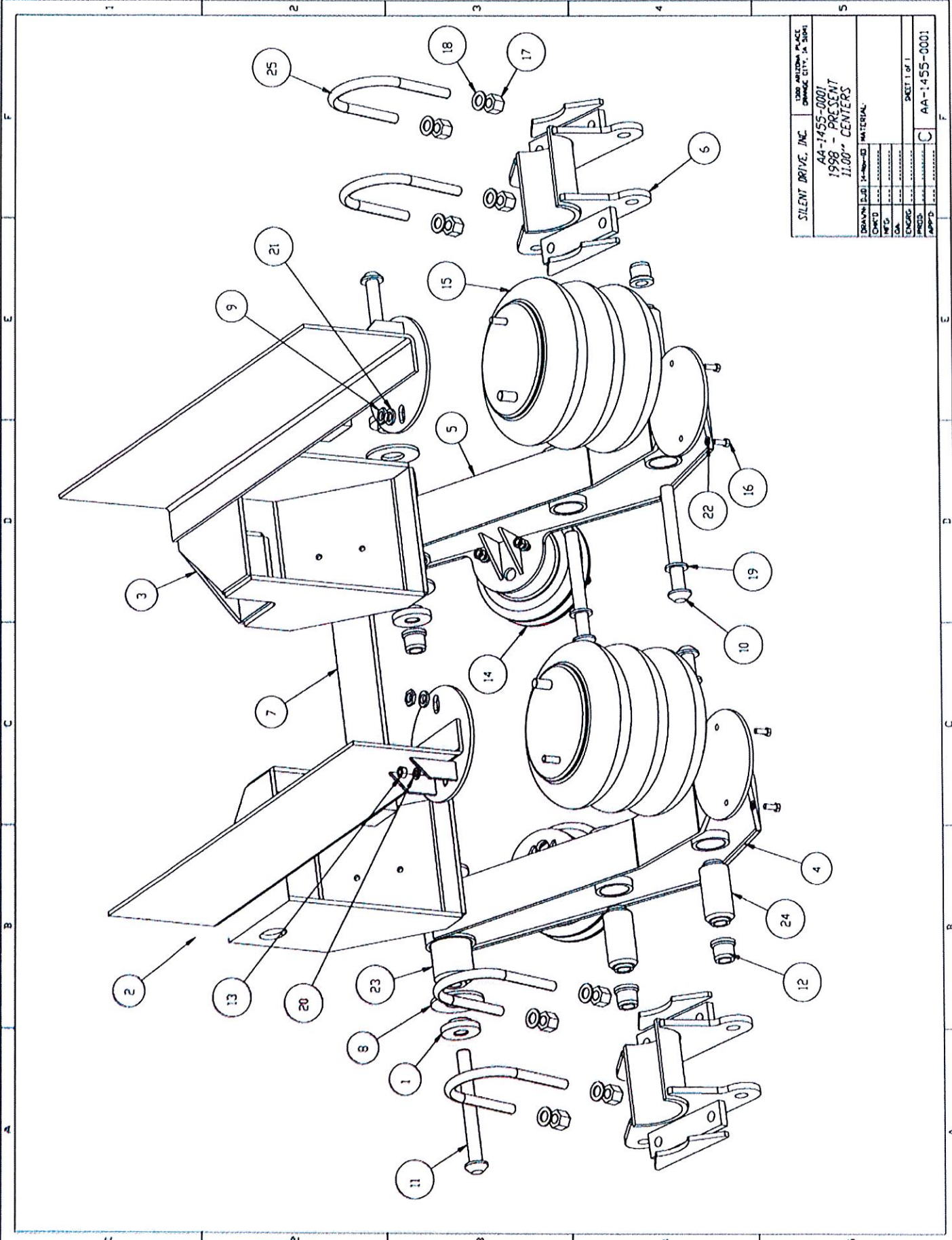

SILENT DRIVE, INC.		3000 WILSON PLACE CHICAGO, ILL. 60641	
AA-1455-0001			
1998 - PRESENT			
11,000" CENTERS			
DRAWN	SUB	14-880-01	MATERIAL
CHECKED			
MFG			
DATE			
ENGINEER			
PROJ			
APP'D			
			SHEET 1 of 1
			AA-1455-0001

AA-1455-0001 (Present)

Updated Last: 8/28/14

NO.	PART NUMBER	QTY.	DESCRIPTION
25	UB-055 (K)	4	U-BOLT 3/4" DIA. X 5 1/4" X 8"
24	PB-5000 (K)	4	AXLE SEAT BUSHINGS
23	PB-3000 (K)	2	PULL ARM BUSHING
22	LW 38ZV	8	3/8" LOCK WASHER
21	LW 34ZV	2	3/4" LOCK WASHER
20	LW 12ZV	6	1/2" LOCK WASHER
19	HWX18	4	1 1/8" WASHER
18	HWX12	8	WASHER, 3/4 EXTRA THICK HARDENED
17	HHN12	8	3/4 HEX HIGH NUT
16	HCC6 16Z	8	BOLT, 3/8"-16 X 1 HX CAP GR. 5Z
15	AS-8027	2	LOAD AIRSPRING
14	AS-6882	2	LIFT AIRSPRING
13	8C8DZD	6	1/2-13 UNC HEX NUT GR. 8
12	100RXSC5	6	HUCK SPIN COLLAR
11	100R662XST8 (K)	2	1"X 9 1/4" HUCK BOLT
10	100R618XST8 (K)	4	1" X 8 3/4" HUCK BOLT
9	341248	2	NUT, JAM 3/4"-16
8	1750-1011	4	PULL ARM HARDENED WASHER
7	1455-6000	1	CROSSMEMBER 23.5"
6	1355-5000-1	2	AXLE SEAT ASSEMBLY (SEE NOTE)
5	1455-4000-1 (K)	1	PULL ARM ASSEMBLY, PS
4	1455-3000-1 (K)	1	PULL ARM ASSEMBLY, DS
3	1455-2000 (K)	1	HANGER ASSEMBLY, PS
2	1455-1000 (K)	1	HANGER ASSEMBLY, DS
1	421-01-9000	4	SLIDING ALIGNMENT COLLAR

Note: Axle Seat: 1455-5000 from 11/98 to 06/12

KIT NUMBER	DESCRIPTION
UB-055	(U-Bolt Kit) 1 U-Bolt, Washers, & High Nuts
PB-5000K	(Bushing Kit for Axle Seat) 4 Bushings, Bolts, & Lock Nut
PB-3000K	(Bushing Kit for Pull Arm) 2 Bushings, Bolts, Lock Nuts & 4 Wear Washers
AC1 95K	(Replacement Kit for Huck Bolt 9 1/4") Pull Arm Bolt, Lock Nut, Washer
HSB1 8A490K	(Replacement Kit for Huck Bolt 8 3/4") Axle Seat Bolt, Lock Nut, Washer
1455-2000K	(Hanger Kit, PS) PS Hanger & 2 Sliding Alignment Collars
1455-1000K	(Hanger Kit, DS) DS Hanger & 2 Sliding Alignment Collars
1455-4000-1K	(Pull Arm Kit, PS) PS Pull Arm, all Bushings, Bolts, Wear Washers, & Nuts
1455-3000-1K	(Pull Arm Kit, DS) DS Pull Arm, all Bushings, Bolts, Wear Washers, & Nuts

CHILDERSBURG TRUCK SERVICE, INC.

PROFESSIONALLY INSTALLED

PINTLE HITCHES

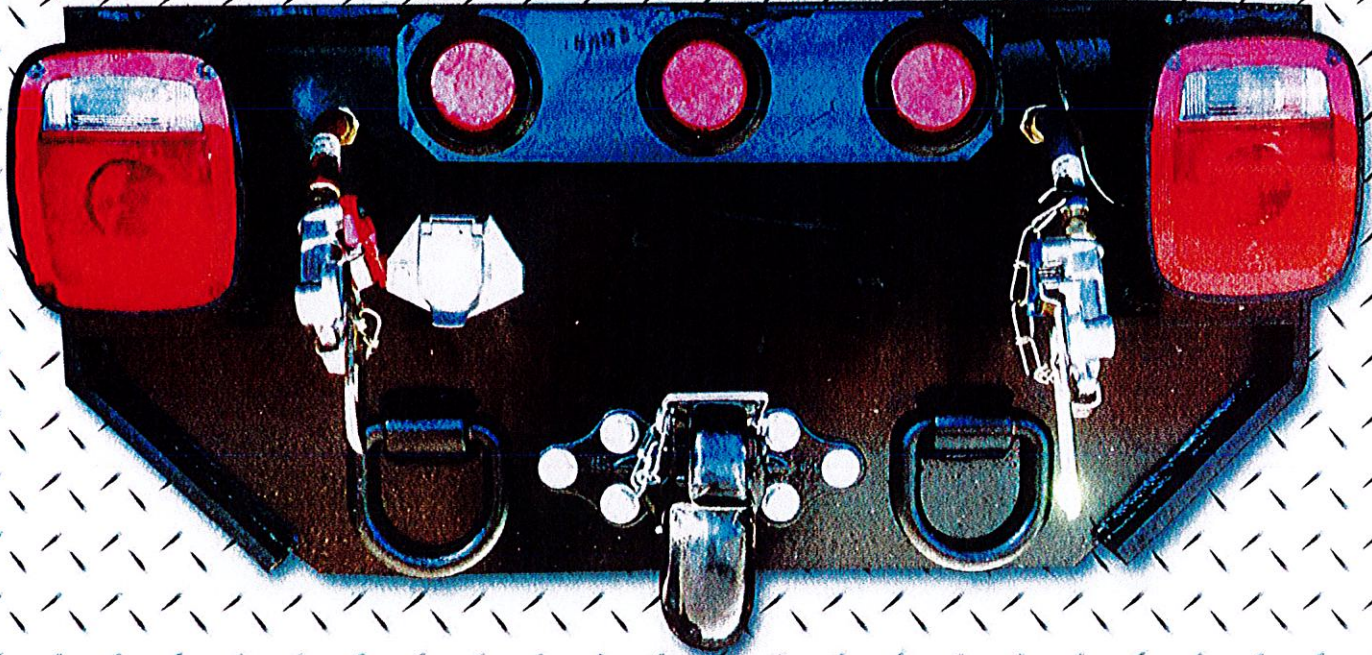

KEY FEATURES OF OUR PINTLE HITCH INSTALLATIONS:

25 TON, HEAVY DUTY PINTLE HITCH - SWIVEL TYPE, SPRING LOADED, AND SAFETY CHAIN RINGS.

MOUNTED ON 1 IN. MINIMUM STEEL PLATE SUPPORTED BY 1/2 IN. X 4 IN. GUSSETS; 3/4 IN. "D-RINGS".

GLAD HANDS MOUNTED WITH 5 IN. X 3/8 IN. AIR BRAKE LINE TO A 1/2 IN. BULKHEAD FITTING THROUGH THE PLATE WITH CUT OFF VALVES ON BACKSIDE OF PLATE.

SEVEN (7) PRONG TRAILER LIGHT SOCKET AND AIR BRAKES HOOKUP.

MOUNTED 26 INS. FROM GROUND WITH TRUCK EMPTY.

CALL CTS TODAY TO SCHEDULE YOUR INSTALLATION (256) 378-3101.

OX BODIES



"As Strong As An Ox"®

MAVERICK



www.OXBODIES.com

MADE IN AMERICA

MAVERICK

4" x 4" x 11 gauge square tubing top rail

• Square bottom dump body design

Dimensions - Maverick

- Lengths of 10'-22'
- Width (ID/OD) 85"/96", 91"/102"
- Side Heights 18"- 72"
- Capacities of 3.9 to 34.6 cubic yards

• Tailgate spreader chain

• Epoxy primer and polyurethane topcoat

			
VM7103 White	VM7085 Silver	VM9900 Black	VM8154 Viper Red
			
VM8273 Vermillion Red	VM5541 Midnight Blue Metallic	VM9670 Candy Apple Red	VM9601 Dark Green

• 1 year warranty on body and installation

• Commercial grade 10 gauge steel (front gate, sides, hoist well)

• 6" diameter, telescoping hoist.

• Commercial grade 7 gauge steel (floor, tailgate)

• Conventional air actuated tailgate

OX BODIES



"As Strong As An Ox" ©

Some equipment shown is optional. Photos are representative only, actual product may vary.

For sand-to-large aggregates and asphalt applications

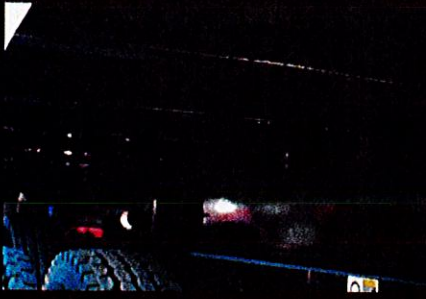

Cross-members, 1.5" x 3" rectangular tubing on 12" centers.



Crossmemberless understructure.

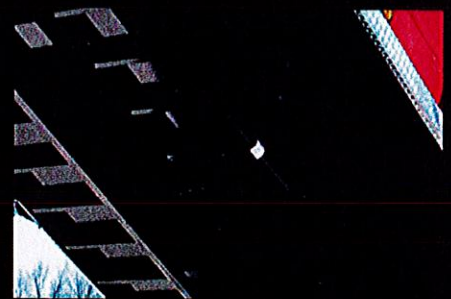

2" x 8" x 3/16" rectangular tubing long sill.

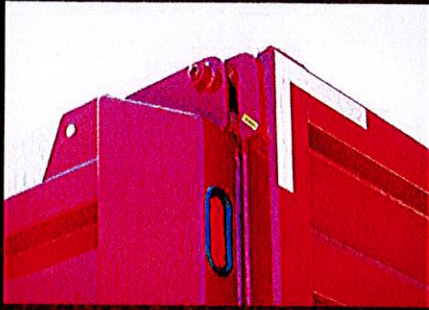

Heavy duty, greaseable steel removable tailgate hinge pin.

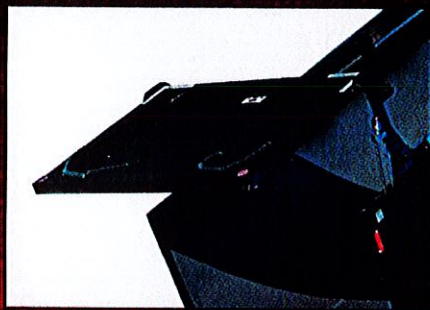

High lift tailgate.



Recessed and rubber grommeted LED lighting.



Optional
Sloped Front

Optional
Insulated Sides



Optional
**Horizontal Side Rib
& Sloped Tailgate**

Horizontal side rib only option shown
(refer to front cover for standard default
option with vertical side braces)



MAVERICK

BASE OPTIONS

for the Maverick

- 4" x 4" x 1/4" square tubing top rail
- Commercial grade 7 gauge, 3/16", or 1/4" steel plus 3/16" AR400 or 1/4" AR450 steel sides and front gate
- Commercial grade, 3/16", 1/4", 3/8", or 1/2" steel plus 3/16" AR400 or 1/4" AR450 steel floor material (with AR material)
- Commercial grade 1/4" steel plus 3/16" AR400 or 1/4" AR450 steel tailgate material
- 24", 36", and 42" cab shields
- Dirt-shedding angles for sides tailgate
- Two-way barn door, double acting, high lift tailgate
- 6" or 12" sloped tailgate
- 1/4" plate or heavy duty (schedule 80) apron 6"-12" in 2" increments
- 8" or 10" wide flange I-Beam
- 8" x 2" rectangular tubing subframe
- Hoist options up to 8" diameter
- Side mounted hydraulic tanks with site glass.
- Insulated sides and front gate
- Manual or electric flip tarp available in mesh or vinyl
- Multiple side board options in (Metal, aluminum, wood)
- Horizontal side bracing
- Coal chute (maximum of three)
- Sealed tailgate
- Additional side recessed and rubber grommeted LED and rear facing lighting
- 1/4", 3/8", 1/2" thick bed liners (various materials)
- Bottom rail covered with aluminum tread plate
- Steel or Tread Brite aluminum gravel guards
- Retractable or air-operated flip up anti-sail mud flaps
- Under body vibrator
- Spreader bar
- Pintle hitches to 50 ton
- Lift axles in 8K, 10K, 13.2K, or 20K steerable, or 20K rigid
- Custom paint colors



OX BODIES



"As Strong As An Ox" ®

719 Columbus Street East • Fayette, AL 35555
Phone 205-932-5720 • 800-844-2519

Photos are representative only, actual product may vary.

Authorized Ox Bodies Dealer